

UD info Corp.

Industrial SATA Solid State Drive HF3-25DC Series Product DataSheet



© 2023 UD INFO Corp. All right reserved.

Specifications are subject to change without prior notice.

UD info CORP.

3F-4, No.8, Ln. 609, Sec. 5, Chongxin Rd., Sanchong Dist., New Taipei City 241, Taiwan (R.O.C.)

TEL: +886-2-7713-6050 FAX: +886-2-8511-3151

E-mail: sales@UDinfo.com.tw

1.	Introduction	6
1.1.	General Description	6
1.2.	Block Diagram	6
2.	Product Specifications.....	7
2.1.	Product Specifications.....	7
2.2.	Device Capacity	7
2.3.	Performance	8
2.4.	POR/SPOR Standby Ready Time	9
2.5.	Thermal Throttling	11
2.6.	TCG Opal 2.0 (Optional, Not Default Function)	13
2.7.	Write Protect Function (Optional)	14
2.8.	Quick Erase Function (Optional)	14
3.	Environmental Specifications	15
3.1.	Environmental Conditions	15
3.1.1.	Temperature Specification	15
3.1.2.	Mechanical Specification	15
3.1.3.	Electrostatic Discharge (ESD)	15
3.1.4.	EMI Compliance	16
3.2.	TBW (Terabytes Written)	16
3.3.	UBER	17
3.4.	MTBF.....	17
4.	Electrical Specifications	19
4.1.	Supply Voltage.....	19
4.2.	Power Consumption.....	19
5.	Interface.....	21
5.1.	Pin Assignment and Descriptions	21
6.	Supported Commands.....	22
6.1.	ATA Command List.....	22
6.2.	Identify Device Data	27
6.3.	S.M.A.R.T. Attributes	32

7.	Physical Dimension	33
8.	Terminology	34
9.	Barcode Description	34
10.	Partnumber Decoder	35



Revision History

Revision	Draft Date	History	Author
1.0	2019/4/11	New release	Golden Lee
1.1	2019/9/3	Add 120GB & 7680GB support Update Performance	Golden Lee
1.2	2019/10/4	Update Performance / TBW / Power consumption	Golden Lee
1.3	2020/4/8	Add write protect and quick erase function support	Golden Lee
1.4	2020/7/30	Add pSLC support	Golden Lee
1.5	2021/3/11	Add Quick Erase and Write Protect description	Golden Lee
1.6	2021/4/28	Removed Bics3 pSLC	Golden Lee
1.7	2021/6/16	Update part number decoder	Golden Lee
1.8	2021/7/20	Add Bics4 support	Golden Lee
1.9	2022/2/17	Add 16TB support	Golden Lee
2.0	2022/5/11	Added BiCS5 support	Golden Lee
2.1	2022/8/2	Added B16C support	Golden Lee
2.2	2023/1/3	Added pSLC support	Golden Lee
2.3	2023/3/29	Removed safety certification	Golden Lee

Product Overview

- **Capacity**
 - TLC: 120GB up to 15360GB (16TB)
 - pSLC: 60GB up to 1920GB
- **Form Factor**
 - 2.5" SATA SSD
- **SATA Interface**
 - SATA Revision 3.1
 - SATA 1.5Gbps, 3Gbps, and 6Gbps interface
- **Flash Interface**
 - Flash Type: 3D TLC
 - Up to 16pcs of BGA132/152 flash
- **Performance**
 - Read up to 550 MB/s
 - Write up to 530 MB/s
- **Power Consumption^{Note1}**
 - Active mode: < 5,000 mW
 - Idle mode: < 1,800 mW
- **Reliability**
 - MTBF: 1,500,000 hours
 - UBER^{Note2} < 1 sector per 10¹⁶ bits read
- **ECC**
 - LDPC / RAID ECC
 - Low density parity check code (>120bit/KBytes)
- **Temperature Range^{Note3}**
 - Operation Temperature:
 - Standard: 0°C ~ 70°C
 - Wide: -40°C ~ 85°C
 - Storage Temperature: -40°C ~ 85°C
- **RoHS Compliant**
- **EMI Compliant**
 - EN55032, CISPR 32 (CE)
 - AS/NZS CISPR 32 (CE)
 - ANSI C63.4 (FCC)
 - CNS 13438 (BSMI)
 - VCCI-CISPR 32 (VCCI)
- **Features Support List**
 - End to end data path protection
 - Thermal throttling
 - Support of AES/TCG OPAL^{Note4}
- **Hardware Power Loss Protection Support**

Notes:

1. Please see "Power Consumption" for details.
2. Uncorrectable Bit Error Rate (UBER)
3. The operation temperature means the case temperature, in which can be detected via the SMART.
4. Supported by separate firmware version. Further information available upon request.

1. INTRODUCTION

1.1. General Description

UDinfo 2.5" SATA SSD delivers all the advantages of flash disk technology with Serial ATA I/II/III interface, including being fully compliant with standard 2.5-inch form factor, providing low power consumption compared to traditional hard drive and hot-swapping when removing/replacing/upgrading flash disks. The device is designed based on the standard 7-pin interface for data segment and 15-pin for power segment. Its capacity could provide a wide range up to 16TB. Moreover, it can reach up to 550MB/s read as well as 530MB/s write high performance based on 3D TLC NAND flash.

1.2. Block Diagram

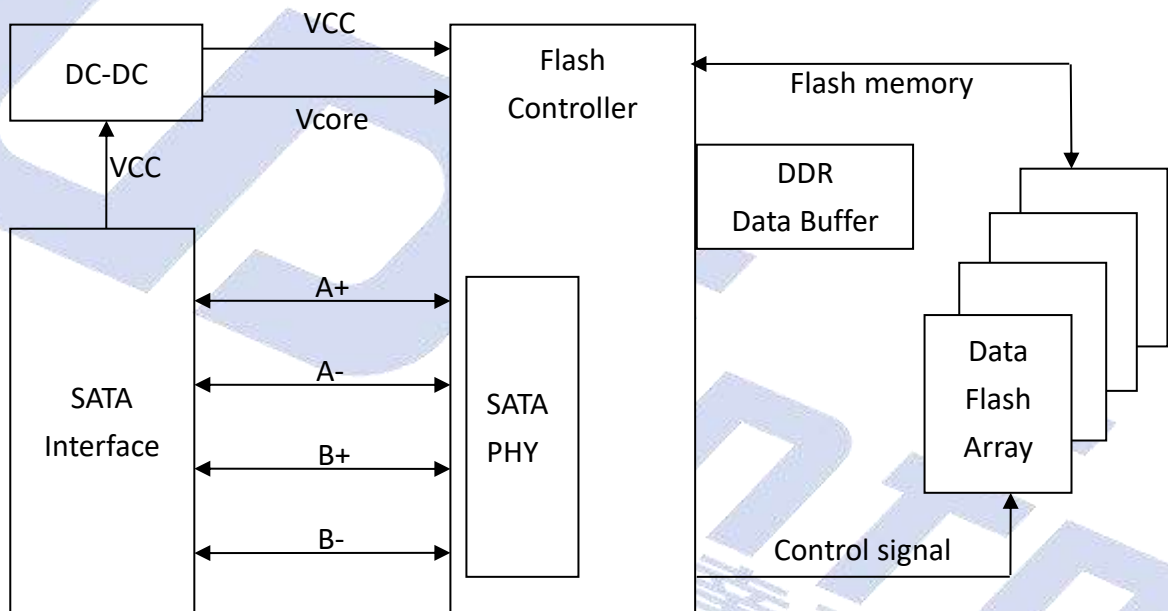

2.5" SATA SSD Block Diagram

2. PRODUCT SPECIFICATIONS

2.1. Product Specifications

- Capacity
 - 120GB up to 15360GB (16TB)
- Electrical/Physical Interface
 - SATA Interface
 - Compliant with SATA Revision 3.1
 - Compatible with SATA 1.5Gbps, 3Gbps and 6Gbps interface
 - Not Support LPM for Industrial grade product.
 - Support expanded register for SATA protocol 48 bits addressing mode
- Support Hardware Write Protect function (Optional)
- Support Hardware Quick Erase function (Optional)
- Support Hardware Power Loss Protection (Optional)
 - Protect data loss, even the last data, during write process when power sudden off.
 - Add-on Polymer Tantalum Capacitors hold-up several milliseconds to keep DRAM data write to NAND Flash.

2.2. Device Capacity

Capacity	IDEMA Standard		User Data Size
	512Bytes/Sector	4KBytes/Sector	
	Total Sectors (LBA)	Total Sectors (LBA)	
60GB	117,231,408	14,653,926	Depended on file management
120GB	234,441,648	29,305,206	
240GB	468,862,128	58,607,766	
480GB	937,703,088	117,212,886	
960GB	1,875,385,008	234,423,126	
1920GB	3,750,748,848	468,843,606	
3840GB	7,501,476,528	937,684,566	
7680GB	15,002,931,888	1,875,366,486	
15360GB	30,005,842,608	3,750,730,326	

Notes:

1. 1 Gigabyte (GB) is equal to 1,000,000,000 Bytes; 1 sector is equal to 512 Bytes.
2. The calculation is following IDEMA Standard.
3. The total actual user data size of the SSD may be less than device capacity due to SSD format, SSD partition, operating system.

EX: OS shows 223.57GB (NTFS) with 240GB SSD.

2.3. Performance

Capacity	Flash Structure	Sequential		4K Random	
		Read (MB/s)	Write (MB/s)	Read (IOPS)	Write (IOPS)
120GB	64GB x 2, BGA, Kioxia BiCS3	550	160	50K	45K
240GB	64GB x 4, BGA, Kioxia BiCS3	550	290	98K	70K
480GB	64GB x 8, BGA, Kioxia BiCS3	550	510	98K	82K
960GB	128GB x 8, BGA, Kioxia BiCS3	550	520	98K	82K
1920GB	128GB x 16, BGA, Kioxia BiCS3	550	520	98K	88K
3840GB	256GB x 16, BGA, Kioxia BiCS3	550	520	98K	88K
7680GB	512GB x 16, BGA, Kioxia BiCS3	550	520	98K	88K
240GB	64GB x 4, BGA, Kioxia BiCS4 ^{Note4}	550	370	90K	89K
480GB	64GB x 8, BGA, Kioxia BiCS4 ^{Note4}	550	530	98K	89K
960GB	256GB x 4, BGA, Kioxia BiCS4 ^{Note4}	550	530	98K	89K
	128GB x 8, BGA, Kioxia BiCS4	550	520	98K	88K
1920GB	256GB x 8, BGA, Kioxia BiCS4	550	520	98K	88K
3840GB	512GB x 8, BGA, Kioxia BiCS4	550	520	98K	88K
7680GB	512GB x 16, BGA, Kioxia BiCS4	550	520	98K	87K
240GB	64GB x 4, BGA, Kioxia BiCS5	550	140	47K	35K
	128GB x 2, BGA, Kioxia BiCS5	550	150	47K	38K
480GB	64GB x 8, BGA, Kioxia BiCS5	550	330	92K	85K
	128GB x 4, BGA, Kioxia BiCS5	550	360	92K	88K
960GB	128GB x 8, BGA, Kioxia BiCS5	550	520	98K	88K
	256GB x 4, BGA, Kioxia BiCS5	550	530	98K	88K
1920GB	256GB x 8, BGA, Kioxia BiCS5	550	520	98K	88K
3840GB	512GB x 8, BGA, Kioxia BiCS5	550	520	98K	88K

UD info CORP. TEL: +886-2-7713-6050 FAX: +886-2-8511-3151

3F-4, No.8, Ln. 609, Sec. 5, Chongxin Rd., Sanchong Dist., New Taipei City 241, Taiwan (R.O.C.)

7680GB	512GB x 16, BGA, Kioxia BiCS5	550	520	98K	88K
15360GB	1TB x 16, BGA, Kioxia BiCS5	550	490	85K	80K
60GB	64GB x 4, BGA, Kioxia BiCS5 pSLC	550	530	94K	88K
120GB	64GB x 8, BGA, Kioxia BiCS5 pSLC	550	530	97K	88K
240GB	128GB x 8, BGA, Kioxia BiCS5 pSLC	550	530	98K	89K
480GB	256GB x 8, BGA, Kioxia BiCS5 pSLC	550	530	98K	89K
960GB	512GB x 8, BGA, Kioxia BiCS5 pSLC	550	530	98K	89K
1920GB	512GB x 16, BGA, Kioxia BiCS5 pSLC	550	530	98K	89K
240GB	128GB x 2, BGA, Micron B16C	550	530	-	-
480GB	128GB x 4, BGA, Micron B16C	550	530	-	-
960GB	128GB x 8, BGA, Micron B16C	550	530	-	-
1920GB	256GB x 8, BGA, Micron B16C	550	530	-	-

Notes:

- Performance may differ according to flash configuration and platform.
- Performance is measured with the follow conditions
 - CrystalDiskMark 6.0, 1GB range, QD32T1 for sequential
 - IOmeter, 1GB range, 4K data size, QD32 for random IOPS
 - OS: Win10 64bit, version 1709
 - Intel Core i7-8700K CPU @ 3.70GHz
- Measurement environment: Room temperature: 20~25°C, humidity: 40~60%RH, DC+5V condition.
- The configurations are for BGAX8 PCBA.

2.4. POR/SPOR Standby Ready Time

Capacity	w/ HW PLP				w/o HW PLP			
	POR ready time		SPOR ready time		POR ready time		SPOR ready time	
	Typ.	Max.	Typ.	Max.	Typ.	Max.	Typ.	Max.
60GB	460	500	1,000	1,200	290	320	900	1,100
120GB	600	700	1,500	3,000	300	320	1,800	3,200
240GB	750	800	1,500	3,000	300	400	1,800	3,200
480GB	1,000	1,200	1,950	3,100	320	400	1,850	3,300
960GB	1,300	1,400	2,600	4,100	320	400	2,300	3,760
1920GB	1,600	1,800	5,000	7,700	400	550	3,800	5,700
3840GB	1,500	1,610	3,740	6,850	320	360	3,120	5,830
7680GB	1,900	1,960	7,020	12,350	380	400	6,840	13,390

15360GB	2,000	2,100	8,000	14,000	400	500	8,000	15,000
---------	-------	-------	-------	--------	-----	-----	-------	--------

Unit: ms

Notes:

1. POR/SPOR stands for following:
 - (a.) POR: Power On Ready. (The ready time variation depends on data recover size.)
 - (b.) SPOR: Power On Ready after Sudden Power Off. (The ready time variation depends on data recover size.)
2. POR/SPOR ready time stands for following:
Power on Time: From Power On to SSD response after drive ready.
3. Measurement environment: Room temperature: 20~25°C, humidity: 40~60%RH, DC+5V condition.



2.5. Thermal Throttling

The purpose of thermal throttling is to prevent any components in a SSD from over-heating during read and write operations. The controller is designed with an on-die thermal sensor and with its accuracy, firmware can apply different levels of throttling to achieve the purpose of protection efficiently and proactively via S.M.A.R.T. reading.

- **SSD Configuration:**

- Example 480GB SSD: (BiCS3 256Gb x 2CE) x 8pcs BGA132/152, total 16CE
- CE = Chip Enable pins, max CE = All 16CE enabled. Total CE numbers depends on SSD configuration

- **Purpose of Thermal Throttling:**

- In order to keep the optimal performance in the safe range of the temperature.

- **Thermal sensors:**

- We have external thermal sensor & on-die thermal sensor (internal controller) to detect temperature. There is 1pcs external thermal sensor on PCB, the position depends on different form factor (The thermal sensor is shown below. The picture is for reference only).
- External thermal sensor would detect flash temperature; On-die thermal sensor detect controller temperature.

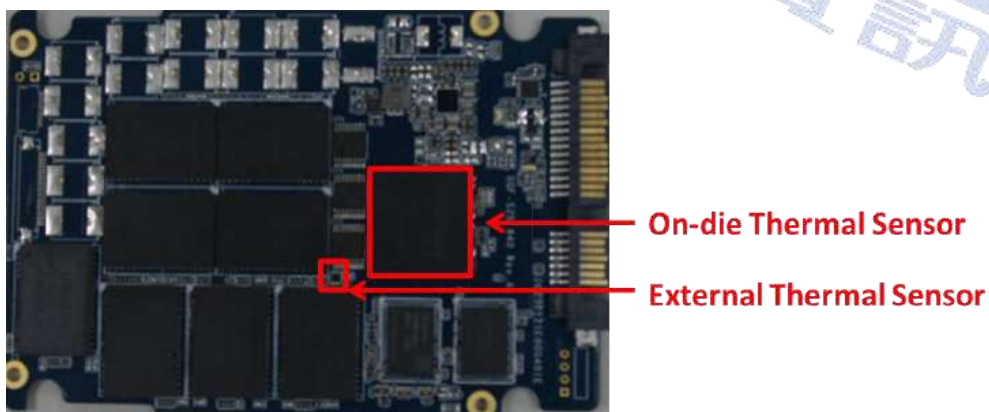

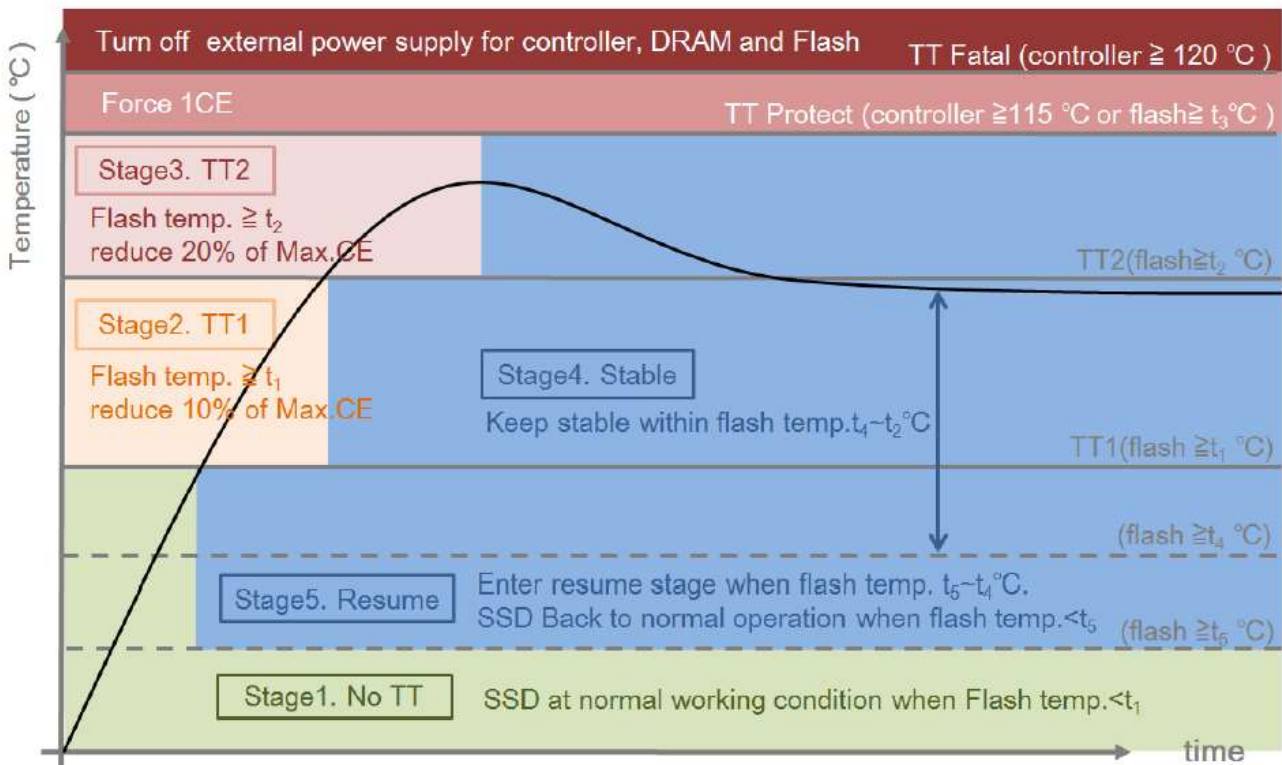

Figure 2-1 Thermal Throttling Schematic

	Operation temp. of Normal-temp. grade: 0-70°C	Operation temp. of Wide-temp. grade: -40-85°C
t₁	68°C	82°C
t₂	70°C	85°C
t₃	80°C	95°C
t₄	64°C	78°C
t₅	60°C	74°C

Notes:

1. TT shown on Figure 2-1 means “Thermal Throttling”.
2. CE = Chip Enable.
3. temp. = temperature

2.6. TCG Opal 2.0 (Optional, Not Default Function)

The Opal specification is a set of specifications for self-encrypting drives published by the Trusted Computing Group (TCG), a non-profit organization that develops, defines, and promotes standards and specifications for secure computing. The Opal Security Subsystem Class(SSC) 2.0 defines the details of data management in storage devices and the classes authority for data access, and secures data from theft and tampering by unauthorized persons who are able to gain access to the storage device or host system.

TCG Opal 2.0 Main Features:

- AES 256-bit Hardware Self Encryption
- Deploy Storage Device & Take Ownership:
The Storage Device is integrated into its target system and ownership transferred by setting or changing the Storage Device's owner credential.
- Activate or Enroll Storage Device:
LBA ranges are configured and data encryption and access control credentials (re)generated and/or set on the Storage Device. Access control is configured for LBA range unlocking.
- Lock & Unlock Storage Device:
Unlocking of one or more LBA ranges by the host and locking of those ranges under host control via either an explicit lock or implicit lock triggered by a reset event. MBR shadowing provides a mechanism to boot into a secure pre-boot authentication environment to handle device unlocking.
- Repurpose & End-of-Life:
Erasure of data within one or more.

2.7. Write Protect Function (Optional)

The write protect function is triggered by pin2 and pin3 short of pin header. This used to set the device as a write protection device after power up. When the function is triggered, the data can't be written to the device. The device is then set as read only.

2.8. Quick Erase Function (Optional)

The Quick Erase is a special feature to allow users to erase user data of SSD by hardware trigger. When this feature is triggered by pin3 and pin4 short of pin header, the SSD controller will write all "0x00" to wipe all the data except firmware area, and the SSD will return to its factory default setting. This feature is particularly useful for emergent circumstances to quickly erase user data.

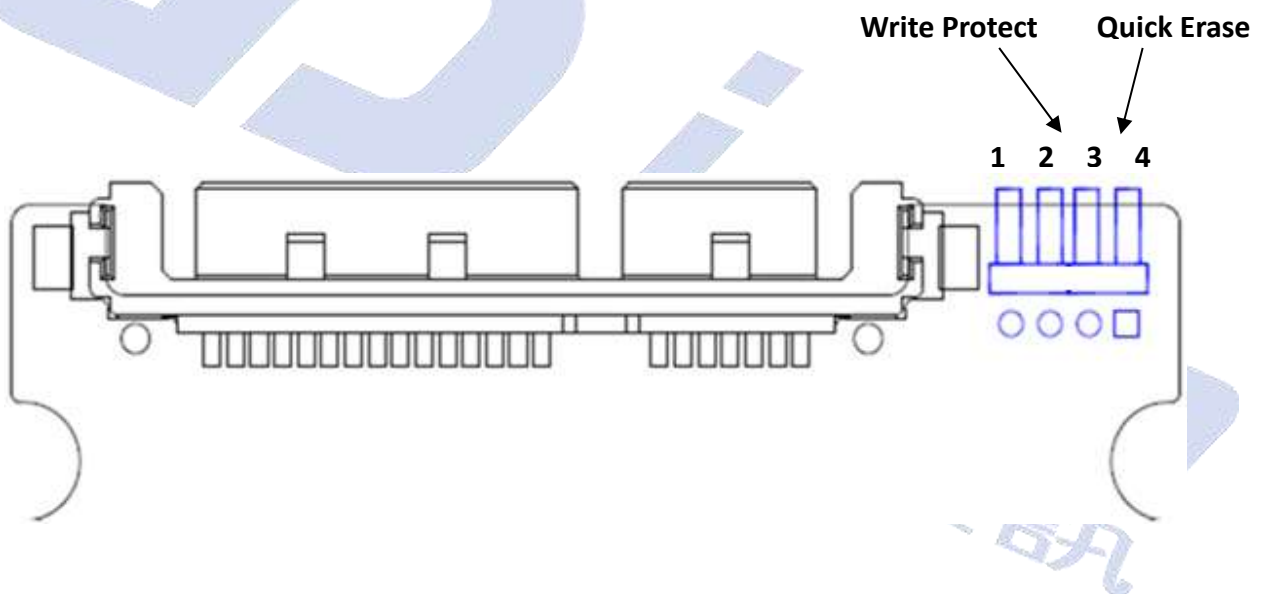

3. ENVIRONMENTAL SPECIFICATIONS



3.1. Environmental Conditions

3.1.1. Temperature Specification

	Mode	Min.	Max.	Unit
Temperature Ranges	Operation (Standard)	0	70	°C
	Operation (Wide)	-40	85	°C
	Storage	-40	85	°C
Humidity	Operation	5	95	%
	Storage	5	95	%
Temperature Cycle Test	Operation (Standard)	0	70	°C
	Operation (Wide)	-40	85	°C
	Storage	-40	85	°C

Notes:

- The operation temperature means the case temperature, in which can be detected via the S.M.A.R.T. Airflow is suggested and it will allow device to be operated at appropriate temperature for each component during heavy workloads environment.

3.1.2. Mechanical Specification

Items			Condition
Shock	Non-operational	Acceleration Force	1500G 0-p with half sine wave (0.5ms)
Vibration	Non-operational	Frequency/Displacement	20Hz~80Hz/1.52mm
		Frequency/Acceleration	80Hz~2000Hz/20G p-p with sine wave
Drop	Non-operational	Height of Drop	80cm free fall
		Number of Drop	6 face of each unit
		Conflicting Material	Concrete floor

3.1.3. Electrostatic Discharge (ESD)

Specification	+/- 4KV
EN 55024, CISPR 24 EN 61000-4-2 and IEC 61000-4-2	Device functions are affected, but EUT will be back to its normal or operational state automatically.

3.1.4. EMI Compliance

EMI Compliance
EN 55032, CISPR 32 (CE)
AS/NZS CISPR 32 (CE)
ANSI C63.4 (FCC)
VCCI-CISPR 32 (VCCI)
CNS 13438 (BSMI)
UL

3.2. TBW (Terabytes Written)

Capacity	Flash Type	TBW
120GB	64GB x 2, BGA, Kioxia BiCS3	188
240GB	64GB x 4, BGA, Kioxia BiCS3	378
480GB	64GB x 8, BGA, Kioxia BiCS3	794
960GB	128GB x 8, BGA, Kioxia BiCS3	1,580
1920GB	128GB x 16, BGA, Kioxia BiCS3	3,118
3840GB	256GB x 16, BGA, Kioxia BiCS3	6,114
7680GB	512GB x 16, BGA, Kioxia BiCS3	11,751
240GB	64GB x 4, BGA, Kioxia BiCS4	395
480GB	64GB x 8, BGA, Kioxia BiCS4	825
960GB	256GB x 4, BGA, Kioxia BiCS4	1,706
1920GB	256GB x 8, BGA, Kioxia BiCS4	3,432
3840GB	512GB x 8, BGA, Kioxia BiCS4	6,942
7680GB	512GB x 16, BGA, Kioxia BiCS4	13,729
240GB	64GB x 4, BGA, Kioxia BiCS5	285
480GB	64GB x 8, BGA, Kioxia BiCS5	700
960GB	128GB x 8, BGA, Kioxia BiCS5	1,600
1920GB	256GB x 8, BGA, Kioxia BiCS5	3,400
3840GB	512GB x 8, BGA, Kioxia BiCS5	7,000
7680GB	512GB x 16, BGA, Kioxia BiCS5	14,000
15360GB	1TB x 16, BGA, Kioxia BiCS5	28,000
60GB	64GB x 4, BGA, Kioxia BiCS5 pSLC	3200
120GB	64GB x 8, BGA, Kioxia BiCS5 pSLC	6600
240GB	128GB x 8, BGA, Kioxia BiCS5 pSLC	13,400
480GB	256GB x 8, BGA, Kioxia BiCS5 pSLC	26,800

UD info CORP. TEL: +886-2-7713-6050 FAX: +886-2-8511-3151

3F-4, No.8, Ln. 609, Sec. 5, Chongxin Rd., Sanchong Dist., New Taipei City 241, Taiwan (R.O.C.)

960GB	512GB x 8, BGA, Kioxia BiCS5 pSLC	55,500
1920GB	512GB x 16, BGA, Kioxia BiCS5 pSLC	119,100
240GB	128GB x 2, BGA, Micron B16C	363
480GB	128GB x 4, BGA, Micron B16C	727
960GB	128GB x 8, BGA, Micron B16C	1,476
1920GB	256GB x 8, BGA, Micron B16C	2,953

Notes:

1. TBW is measured by JEDEC Client 219A workload.
2. TBW may differ according to flash configuration and platform.
3. The SSD supports trim function. If Operation System does not support trim command, performance and TBW will be affected. (Like certain Windows OS, Linux kernel version before 2.6.33, other OS please reference each own user manual)
4. The endurance of SSD could be estimated based on user behavior, NAND endurance cycles, and write amplification factor.

3.3. UBER

Capacity	UBER
60GB ~ 15360GB	< 1 sector per 10 ¹⁶ bits read

Notes:

1. UBER (Uncorrectable Bit Error Rates) means the uncorrectable error per bits read.
2. UBER = FER (fail rate) / Data Size (user data bit).
3. FER = uncorrectable ECC frame number / total ECC frame number.
4. The LDPC for TLC ECC capability > 120bit/KB.

3.4. MTBF

MTBF, an acronym for Mean Time between Failures, is a measure of reliability of a device. Its value represents the average time between a repair and the next failure. The unit of MTBF is in hours. The higher the MTBF value, the higher the reliability of the device.

Our MTBF result is based on simulation software (Relx 7.3). Please note that a lower MTBF should be expected for higher capacity drives, and we apply the lowest MTBF for all capacities.

Capacity	MTBF
60GB ~ 15360GB	1.5 million hours



4. ELECTRICAL SPECIFICATIONS



4.1. Supply Voltage

Parameter	Rating
Operating Voltage	5V ± 5%
Rise Time (Max/Min)	100ms / 0.1ms
Fall Time (Max/Min)	5s / 10ms
Min. off Time	1s

Notes:

1. Minimum time between power removed from SSD ($V_{cc} < 100$ mV) and power re-applied to the drive.
2. Ensure the voltage of each power domain in SSD has enough time to discharge less than 0.1V.
3. Rise Time during from 10% to 90% of 5V.
4. Fall Time during from 90% to 10% of 5V.

4.2. Power Consumption

Capacity	Flash Type	Read	Write	Idle
120GB	64GB x 2, BGA, Kioxia BiCS3	2,000	2,100	1,100
240GB	64GB x 4, BGA, Kioxia BiCS3	2,200	2,400	1,100
480GB	64GB x 8, BGA, Kioxia BiCS3	2,400	2,900	1,300
960GB	128GB x 8, BGA, Kioxia BiCS3	2,700	3,100	1,600
1920GB	128GB x 16, BGA, Kioxia BiCS3	3,000	3,200	1,600
3840GB	256GB x 16, BGA, Kioxia BiCS3	3,200	4,000	1,600
7680GB	512GB x 16, BGA, Kioxia BiCS3	3,600	5,000	1,800
240GB	64GB x 4, BGA, Kioxia BiCS4 ^{Note6}	2,300	2,500	1,250
480GB	64GB x 8, BGA, Kioxia BiCS4 ^{Note6}	2,300	3,300	1,250
960GB	256GB x 4, BGA, Kioxia BiCS4 ^{Note6}	2,100	3,300	1,150
	128GB x 8, BGA, Kioxia BiCS4	2,400	3,800	1,300
1920GB	256GB x 8, BGA, Kioxia BiCS4	2,550	3,100	1,400
3840GB	512GB x 8, BGA, Kioxia BiCS4	2,950	3,500	1,500
7680GB	512GB x 16, BGA, Kioxia BiCS4	3,050	3,850	1,500
240GB	64GB x 4, BGA, Kioxia BiCS5	2,000	2,300	1,300
	128GB x 2, BGA, Kioxia BiCS5	2,000	2,000	1,200
480GB	64GB x 8, BGA, Kioxia BiCS5	2,100	2,700	1,300

UD info CORP. TEL: +886-2-7713-6050 FAX: +886-2-8511-3151

3F-4, No.8, Ln. 609, Sec. 5, Chongxin Rd., Sanchong Dist., New Taipei City 241, Taiwan (R.O.C.)

	128GB x 4, BGA, Kioxia BiCS5	2,000	2,600	1,200
960GB	128GB x 8, BGA, Kioxia BiCS5	2,200	3,200	1,300
	256GB x 4, BGA, Kioxia BiCS5	2,000	3,000	1,200
1920GB	256GB x 8, BGA, Kioxia BiCS5	2,400	3,400	1,400
3840GB	512GB x 8, BGA, Kioxia BiCS5	2,500	3,600	1,500
7680GB	512GB x 16, BGA, Kioxia BiCS5	2,600	3,700	1,500
15360GB	1TB x 16, BGA, Kioxia BiCS5	3,500	4,500	1,600
60GB	64GB x 4, BGA, Kioxia BiCS5 pSLC	2,100	2,000	1,300
120GB	64GB x 8, BGA, Kioxia BiCS5 pSLC	2,100	2,000	1,300
240GB	128GB x 8, BGA, Kioxia BiCS5 pSLC	2,200	2,100	1,400
480GB	256GB x 8, BGA, Kioxia BiCS5 pSLC	2,400	2,200	1,400
960GB	512GB x 8, BGA, Kioxia BiCS5 pSLC	2,500	2,300	1,500
1920GB	512GB x 16, BGA, Kioxia BiCS5 pSLC	2,600	2,900	1,500
240GB	128GB x 2, BGA, Micron B16C	2,100	2,000	1,100
480GB	128GB x 4, BGA, Micron B16C	2,200	2,900	1,300
960GB	128GB x 8, BGA, Micron B16C	2,400	3,000	1,300
1920GB	256GB x 8, BGA, Micron B16C	2,400	3,200	1,300

Unit: mW

Notes:

1. The average value of power consumption is achieved based on 100% conversion efficiency.
2. The measured power voltage is 5V.
3. Measurement environment: Room temperature: 20~25°C, humidity: 40~60%RH.
4. Sequential R/W is measured while testing 1GB sequential R/W 5 times by CrystalDiskMark.
5. Power Consumption may differ according to flash configuration and platform.
6. The configurations are for BGAX8 PCBA.

5. INTERFACE



5.1. Pin Assignment and Descriptions

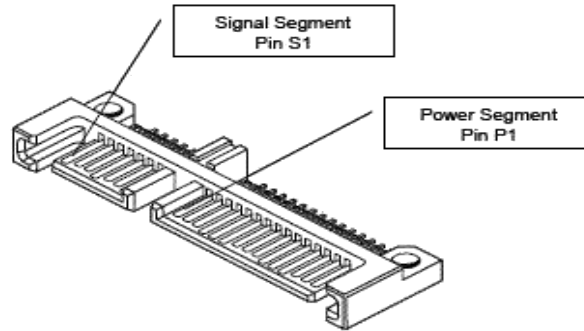

- Signal Segment Pin Assignment and Description

Pin Number	Function
S1	GND
S2	A+ (Differential Signal Pair A)
S3	A – (Differential Signal Pair A)
S4	GND
S5	B – (Differential Signal Pair B)
S6	B+ (Differential Signal Pair B)
S7	GND

- Power Segment Pin Assignment and Description

Pin Number	Function
P1	Not Used (3.3V)
P2	Not Used (3.3V)
P3	DEVSLP
P4	GND
P5	GND
P6	GND
P7	5V pre-charge
P8	5V
P9	5V
P10	GND
P11	Reserved
P12	GND
P13	Not Used (12V)
P14	Not Used (12V)
P15	Not Used (12V)

6. SUPPORTED COMMANDS



6.1. ATA Command List

Op Code	Support	Description	Op Code	Support	Description	
00h	Y	NOP	B6h	12h	-	NV Cache: QUERY NV CACHE PINNED SET DMA EXT
03h	-	CFA REQUEST EXTENDED ERROR	B6h	13h	-	NV Cache: QUERY NV CACHE MISSES DMA EXT
06h	Y	DATA SET MANAGEMENT	B6h	14h	-	NV Cache: FLUSH NV CACHE
08h	-	DEVICE RESET	C4h	Y	READ MULTIPLE	
0Bh	-	REQUEST SENSE DATA EXT	C5h	Y	WRITE MULTIPLE	
10h	Y	RECALIBRATE	C6h	Y	SET MULTIPLE MODE	
11h-1Fh	-	RECALIBRATE	C7h	-	READ DMA QUEUED	
20h	Y	READ SECTOR(S)	C8h	Y	READ DMA	
21h	Y	READ SECTOR(S) WITHOUT RETRY	C9h	Y	READ DMA WITHOUT RETRY	
22h	-	READ LONG	CAh	Y	WRITE DMA	
23h	-	READ LONG WITHOUT RETRY	CBh	Y	WRITE DMA WITHOUT RETRY	
24h	Y	READ SECTOR(S) EXT	CCh	-	WRITE DMA QUEUED	
25h	Y	READ DMA EXT	CDh	-	CFA WRITE MULTIPLE WITHOUT ERASE	
26h	-	READ DMA QUEUED EXT	CEh	Y	WRITE MULTIPLE FUA EXT	
27h	Y	READ NATIVE MAX ADDRESS EXT	D1h	-	CHECK MEDIA CARD TYPE	
29h	Y	READ MULTIPLE EXT	DAh	-	GET MEDIA STATUS	
2Ah	-	READ STREAM DMA EXT	DEh	-	MEDIA LOCK	
2Bh	-	READ STREAM EXT	DFh	-	MEDIA UNLOCK	
2Fh	Y	READ LOG EXT	E0h	Y	STANDBY IMMEDIATE	
30h	Y	WRITE SECTOR(S)	E1h	Y	IDLE IMMEDIATE	
31h	Y	WRITE SECTOR(S) WITHOUT RETRY	E2h	Y	STANDBY	
32h	-	WRITE LONG	E3h	Y	IDLE	
33h	-	WRITE LONG WITHOUT RETRY	E4h	Y	READ BUFFER	
34h	Y	WRITE SECTOR(S) EXT	E5h	Y	CHECK POWER MODE	
35h	Y	WRITE DMA EXT	E6h	Y	SLEEP	
36h	-	WRITE DMA QUEUED EXT	E7h	Y	FLUSH CACHE	
37h	Y	SET MAX ADDRESS EXT	E8h	Y	WRITE BUFFER	

UD info CORP. TEL: +886-2-7713-6050 FAX: +886-2-8511-3151

3F-4, No.8, Ln. 609, Sec. 5, Chongxin Rd., Sanchong Dist., New Taipei City 241, Taiwan (R.O.C.)

Op Code	Support	Description	Op Code	Support	Description		
38h	-	CFA WRITE SECTORS WITHOUT ERASE	E9h	Y	READ BUFFER DMA		
39h	Y	WRITE MULTIPLE EXT	EAh	Y	FLUSH CACHE EXT		
3Ah	-	WRITE STREAM DMA EXT	EBh	Y	WRITE BUFFER DMA		
3Bh	-	WRITE STREAM EXT	ECh	Y	IDENTIFY DEVICE		
3Ch	-	WRITE VERIFY	EDh	-	MEDIA EJECT		
3Dh	Y	WRITE DMA FUA EXT	EEh	-	IDENTIFY DEVICE DMA		
3Eh	-	WRITE DMA QUEUED FUA EXT	EFh	01h	-	SET FEATURES: Enable 8-bit PIO transfer mode (CFA feature set only)	
3Fh	Y	WRITE LOG EXT	EFh	02h	Y	SET FEATURES: Enable write cache	
40h	Y	READ VERIFY SECTOR(S)	EFh	03h	Y	SET FEATURES: Set transfer mode based on value in Count field	
41h	Y	READ VERIFY SECTOR(S) WITHOUT RETRY	EFh	05h	Y	SET FEATURES: Enable advanced power management	
42h	Y	READ VERIFY SECTOR(S) EXT	EFh	06h	-	SET FEATURES: Enable Power-Up In Standby feature set	
44h	-	Reserved	EFh	07h	-	SET FEATURES: Power-Up In Standby feature set device spin-up	
45h	O	WRITE UNCORRECTABLE EXT	EFh	0Ah	-	SET FEATURES: Enable CFA power mode 1	
47h	Y	READ LOG DMA EXT	EFh	0Bh	-	SET FEATURES: Enable Write-Read-Verify feature set	
50h	-	FORMAT TRACK	EFh	10h	01h	-	SET FEATURES: Enable use of Serial ATA feature
51h	-	CONFIGURE STREAM	EFh	10h	02h	Y	SET FEATURES: Enable DMA Setup FIS Auto-Activate optimization
57h	Y	WRITE LOG DMA EXT	EFh	10h	03h	Y	SET FEATURES: Enable Device-initiated interface power state (DIPM) transitions
60h	Y	READ FPDMA QUEUED	EFh	10h	04h	-	SET FEATURES: Enable use of Serial ATA feature
61h	Y	WRITE FPDMA QUEUED	EFh	10h	05h	-	SET FEATURES: Enable use of Serial ATA feature
70h	Y	SEEK	EFh	10h	06h	O	SET FEATURES: Enable Software Settings Preservation (SSP)

UD info CORP. TEL: +886-2-7713-6050 FAX: +886-2-8511-3151

3F-4, No.8, Ln. 609, Sec. 5, Chongxin Rd., Sanchong Dist., New Taipei City 241, Taiwan (R.O.C.)

Op Code	Support	Description	Op Code	Support	Description
71-76h	-	SEEK	EFh 10h 07h	Y	SET FEATURES: Enable Device Automatic Partial to Slumber transitions
77h	Y	SET DATE AND TIME EXT	EFh 10h 09h	O	SET FEATURES: Enable Device Sleep
78h	Y	ACCESSIBLE MAX ADDRESS CONFIGURATION	EFh 42h	-	SET FEATURES: Enable Automatic Acoustic Management feature set
79-7Fh	-	SEEK	EFh 43h	-	SET FEATURES: Set Maximum Host Interface Sector Times
87h	-	CFA TRANSLATE SECTOR	EFh 44h	-	SET FEATURES: Vendor Specific ECC byte
90h	Y	EXECUTE DEVICE DIAGNOSTIC	EFh 55h	Y	SET FEATURES: Disable read look-ahead feature
91h	Y	INITIALIZE DEVICE PARAMETERS	EFh 5Dh	-	SET FEATURES: Enable release interrupt
92h	Y	DOWNLOAD MICROCODE	EFh 5Eh	-	SET FEATURES: Enable service interrupt
93h	Y	DOWNLOAD MICROCODE DMA	EFh 5Fh	-	SET FEATURES: Enable NDRQ Feature
94h	-	STANDBY IMMEDIATE	EFh 66h	Y	SET FEATURES: Disable reverting to power-on defaults
95h	-	IDLE IMMEDIATE	EFh 81h	-	SET FEATURES: Disable 8-bit PIO transfer mode (CFA feature set only)
96h	-	STANDBY	EFh 82h	Y	SET FEATURES: Disable write cache
97h	-	IDLE	EFh 85h	Y	SET FEATURES: Disable advanced power management
98h	-	CHECK POWER MODE	EFh 86h	-	SET FEATURES: Disable Power-Up In Standby feature set
99h	-	SLEEP	EFh 8Ah	-	SET FEATURES: Disable CFA power mode
A0h	-	PACKET	EFh 8Bh	-	SET FEATURES: Disable Write-Read-Verify feature set
A1h	-	IDENTIFY PACKET DEVICE	EFh 90h 01h	-	SET FEATURES: Disable use of Serial ATA feature
A2h	-	SERVICE	EFh 90h 02h	Y	SET FEATURES: Disable DMA Setup FIS Auto-Activate optimization

Op Code		Support	Description	Op Code		Support	Description
B0h	D0h	Y	SMART: READ DATA	EFh	90h 03h	Y	SET FEATURES: Disable Device-initiated interface power state (DIPM) transitions
B0h	D1h	Y	SMART: READ ATTRIBUTE THRESHOLDS	EFh	90h 04h	-	SET FEATURES: Disable use of Serial ATA feature
B0h	D2h	Y	SMART: ENABLE/DISABLE AUTOSAVE	EFh	90h 05h	-	SET FEATURES: Disable use of Serial ATA feature
B0h	D3h	Y	SMART: SAVE ATTRIBUTE VALUES	EFh	90h 06h	Y	SET FEATURES: Disable Software Settings Preservation (SSP)
B0h	D4h	Y	SMART: EXECUTE OFF-LINE IMMEDIATE	EFh	90h 07h	Y	SET FEATURES: Disable Device Automatic Partial to Slumber transitions
B0h	D5h	Y	SMART: READ LOG	EFh	90h 09h	0	SET FEATURES: Disable Device Sleep
B0h	D6h	Y	SMART: WRITE LOG	EFh	AAh	Y	SET FEATURES: Enable read look-ahead feature
B0h	D8h	Y	SMART: ENABLE OPERATIONS	EFh	BBh	-	SET FEATURES: Default ECC byte
B0h	D9h	Y	SMART: DISABLE OPERATIONS	EFh	C2h	-	SET FEATURES: Disable Automatic Acoustic Management feature set
B0h	DAh	Y	SMART: RETURN STATUS	EFh	C3h	-	SET FEATURES: Enable/Disable the Sense Data Reporting feature set
B0h	DBh	Y	SMART: ENABLE/DISABLE AUTOMATIC OFF-LINE	EFh	CCh	Y	SET FEATURES: Enable reverting to power-on defaults
B0h	E0h	-	SMART: Vendor specific	EFh	DDh	-	SET FEATURES: Disable release interrupt
B1h	C0h	Y	DEVICE CONFIGURATION: RESTORE	EFh	DEh	-	SET FEATURES: Disable SERVICE interrupt
B1h	C1h	Y	DEVICE CONFIGURATION: FREEZE LOCK	EFh	DFh	-	SET FEATURES: Disable NDRQ Feature
B1h	C2h	Y	DEVICE CONFIGURATION: IDENTIFY	F1h		Y	SECURITY SET PASSWORD
B1h	C3h	Y	DEVICE CONFIGURATION: SET	F2h		Y	SECURITY UNLOCK
B1h	C4h	Y	DEVICE CONFIGURATION: IDENTIFY DMA	F3h		Y	SECURITY ERASE PREPARE
B1h	C5h	Y	DEVICE CONFIGURATION: SET DMA	F4h		Y	SECURITY ERASE UNIT

Op Code		Support	Description	Op Code		Support	Description
B4h	0000h	O	SANITIZE DEVICE: SANITIZE STATUS EXT	F5h		Y	SECURITY FREEZE LOCK
B4h	0011h	O	SANITIZE DEVICE: CRYPTO SCRAMBLE EXT	F6h		Y	SECURITY DISABLE PASSWORD
B4h	0012h	O	SANITIZE DEVICE: BLOCK ERASE EXT	F8h		Y	READ NATIVE MAX ADDRESS
B4h	0014h	O	SANITIZE DEVICE: OVERWRITE EXT	F9h	00h	Y	SET MAX: SET MAX ADDRESS
B4h	0020h	O	SANITIZE DEVICE: SANITIZE FREEZE LOCK EXT	F9h	01h	Y	SET MAX: SET MAX PASSWORD
B4h	0040h	O	SANITIZE DEVICE: SANITIZE ANTIFREEZE LOCK EXT	F9h	02h	Y	SET MAX: SET MAX LOCK
B6h	00h	-	NV Cache: SET NV CACHE POWER MODE EXT	F9h	03h	Y	SET MAX: SET MAX UNLOCK
B6h	01h	-	NV Cache: RETURN FROM NV CACHE POWER MODE EXT	F9h	04h	Y	SET MAX: SET MAX FREEZE LOCK
B6h	10h	-	NV Cache: ADD LBA(S) TO NV CACHE PINNED SET DMA EXT	F9h	05h	Y	SET MAX: SET MAX SET PASSWORD DMA
B6h	11h	-	NV Cache: REMOVE LBA(S) FROM NV CACHE PINNED SET DMA EXT	F9h	06h	Y	SET MAX: SET MAX UNLOCK DMA

Notes:

“Y” means “Support”.

“O” means “Option, default not support”.

“-” means “Not support”.

6.2. Identify Device Data

The following table details the sector data returned by the IDENTIFY DEVICE command of ATA8-ACS4 SPEC.

Word	F: Fixed V: Variable X: retired/obsolete /reserved	Description	Default Value
0	F	General configuration bit-significant information	0040h
1	X	Obsolete – Number of logical cylinders	*1
2	F	Specific configuration	C837h
3	X	Obsolete – Number of logical heads (16)	0010h
4-5	X	Retired	00000000h
6	X	Obsolete – Number of logical sectors per logical track (63)	003Fh
7-8	X	Reserved for assignment by the Compact Flash Association	00000000h
9	X	Retired	0000h
10-19	V	Serial number (20 ASCII characters)	Varies
20-21	X	Retired	0000h
22	X	Obsolete	0000h
23-26	V	Firmware revision (8 ASCII characters)	Varies
27-46	V	Model number (xxxxxxxx)	Varies
47	F	7:0- Maximum number of sectors transferred per interrupt on MULTIPLE commands	8010h
48	F	Reserved	4000h
49	F	Capabilities	2F00h
50	F	Capabilities	4000h
51-52	X	Obsolete	00000000h
53	F	Words 88 and 70:64 valid	0007h
54	X	Obsolete – Number of logical cylinders	*1
55	X	Obsolete – Number of logical heads (16)	0010h
56	X	Obsolete – Number of logical sectors per track (63)	003Fh
57-58	X	Obsolete – Current capacity in sectors	*2
59	F	Number of sectors transferred per interrupt on MULTIPLE commands	0110h
60-61	V	Maximum number of sector (28bit LBA mode)	*3

UD info CORP. TEL: +886-2-7713-6050 FAX: +886-2-8511-3151

3F-4, No.8, Ln. 609, Sec. 5, Chongxin Rd., Sanchong Dist., New Taipei City 241, Taiwan (R.O.C.)

Word	F: Fixed V: Variable X: retired/obsolete /reserved	Description	Default Value
62	X	Obsolete	0000h
63	F	Multi-word DMA modes supported/selected	0407h
64	F	PIO modes supported	0003h
65	F	Minimum Multiword DMA transfer cycle time per word	0078h
66	F	Manufacturer's recommended Multiword DMA transfer cycle time	0078h
67	F	Minimum PIO transfer cycle time without flow control	0078h
68	F	Minimum PIO transfer cycle time with IORDY flow control	0078h
69	F	Additional Supported	1F00h
70	X	Reserved	0000h
71-74	X	Reserved for the IDENTIFY PACKET DEVICE command	000000000000 0000h
75	F	Queue depth	001Fh
76	F	Serial SATA capabilities	850Eh
77	F	Supported Serial ATA Phy speed	0006h
78	F	Serial ATA features supported	004Ch
79	F	Serial ATA features enabled	0040H
80	F	Major Version Number	0FF8h
81	F	Minor Version Number	0000h
82	F	Command set supported	746Bh
83	F	Command set supported	7D01h
84	F	Command set/feature supported extension	4163h
85	F	Command set/feature supported or enabled	7469h
86	F	Command set/feature supported or enabled	BC01h
87	F	Command set/feature supported or enabled	4163h
88	F	Ultra DMA Modes	007Fh
89	F	Time required for Normal Erase mode SECURITY ERASE UNIT command	000Ah
90	F	Time required for an Enhanced Erase mode SECURITY ERASE UNIT command	001Eh

Word	F: Fixed V: Variable X: retired/obsolete /reserved	Description	Default Value
91	F	Current advanced power management value	0000h
92	F	Master Password Revision Code	FFFEh
93	F	Hardware reset result. The contents of the bits (12:0) of this word can be changed only during the execution of hardware reset.	0000h
94	X	Vendor's recommended and actual acoustic management value	0000h
95	F	Stream Minimum Request Size	0000h
96	F	Streaming Transfer Time – DMA	0000h
97	F	Streaming Access Latency – DMA and PIO	0000h
98-99	F	Streaming Performance Granularity	0000h
100-103	V	Maximum user LBA for 48 bit Address feature set	*4
104	F	Streaming Transfer Time – PIO	0000h
105	F	Maximum number of 512-byte blocks per DATA SET MANAGEMENT command	0008h
106	F	Physical sector size/Logical sector size	4000h
107	F	Inter-seek delay for ISO-7779 acoustic testing in microseconds	0000h
108-111	F	Reserved	Varies
112-115	X	Reserved	000000000000 0000h
116	X	Reserved	0000h
117-118	F	Words per logical Sector	00000000h
119	F	Supported settings	401Ch
120	F	Command set/Feature Enabled/Supported	401Ch
121-126	X	Reserved	0h
127	X	Obsolete	0h
128	F	Security status	0021h
129-159	V	Vendor specific	Varies
160	X	Compact Flash Association (CFA) power mode 1	0h
161-167	X	Reserved for assignment by the CFA	0h
168	V	Device Nominal Form Factor	Varies

Word	F: Fixed V: Variable X: retired/obsolete /reserved	Description	Default Value
169	F	DATA SET MANAGEMENT command is supported	0001h
170-173	F	Additional Product Identifier	0h
174-175	X	Reserve	0h
176-205	F	Current media serial number	0h
206	F	SCT Command Transport(0039h
207-208	X	Reserved	0h
209	F	Alignment of logical blocks within a physical block	4000h
210-211	F	Write-Read-Verify Sector Count Mode 3 (not support)	0000h
212-213	F	Write-Read-Verify Sector Count Mode 2 (not support)	0000h
214-216	X	NV Cache relate (not support)	0000h
217	F	Non-rotating media device	0001h
218	X	Reserved	0h
219	X	NV Cache relate (not support)	0h
220	V	Write read verify feature set current mode	0h
221	X	Reserved	0h
222	F	Transport major version number	10FFh
223	F	Transport minor version number	0h
224-229	X	reserved	0h
230-233	F	Extend number of user addressable sectors	0h
234	F	Minimum number of 512-byte data blocks per DOWNLOAD MICROCODE command for mode 03h	0001h
235	F	Maximum number of 512-byte data blocks per DOWNLOAD MICROCODE command for mode 03h	FFFEh
236-242	X	Reserved	0h
243	X	Reserved	0000h
244-254	X	Reserved	0h
255	F	Integrity word (Checksum and Signature)	XXA5h XX is variable

■ List of Device Identification for Each Capacity

Capacity (GB)	*1 (Word 1/Word 54)	*2 (Word 57–58)	*3 (Word 60–61)	*4 (Word 100–103)
60	3FFFh	FBFC10h	6FCCF30h	6FCCF30h
120	3FFFh	FBFC10h	DF94BB0h	DF94BB0h
128	3FFFh	FBFC10h	EE7C2B0h	EE7C2B0h
240	3FFFh	FBFC10h	0FFFFFFFh	1BF244B0h
256	3FFFh	FBFC10h	0FFFFFFFh	1DC32B0h
480	3FFFh	FBFC10h	0FFFFFFFh	37E436B0
512	3FFFh	FBFC10h	0FFFFFFFh	3B9E12B0h
960	3FFFh	FBFC10h	0FFFFFFFh	6FC81AB0h
1024	3FFFh	FBFC10h	0FFFFFFFh	773BD2B0h
1920	3FFFh	FBFC10h	0FFFFFFFh	DF8FE2B0h
2048	3FFFh	FBFC10h	0FFFFFFFh	EE7752B0h
3840	3FFFh	FBFC10h	0FFFFFFFh	1BF1F72B0h
7680	3FFFh	FBFC10h	0FFFFFFFh	37E3E92B0h
15360	3FFFh	FBFC10h	0FFFFFFFh	6FC7CD2B0h

6.3. S.M.A.R.T. Attributes

Attribute ID	Description
01h	Number of Accumulation of Uncorrectable Error.
09h	Power on Hours Count.
0Ch	Drive Power Cycle Count (number of accumulation of power on/off cycles)
A8h	SATA PHY Error Count (Only record from power on, when power off this value will clear to zero. These values include all PHY error count, ex data FIS CRC, code error, disparity error, command FIS CRC.....)
AAh	Bad Block Count (early bad count and later bad count)
ADh	Erase Count (max. erase count and average erase count)
C0h	Number of Unexpected Power Loss
C2h	Temperature
DAh	Number of Accumulation CRC Error (read/write data FIS CRC error)
E7h	SSD Life Remaining
F1h	Host Write(GB)



7. PHYSICAL DIMENSION

Dimension_A: 100.10mm(L) x 69.85mm(W) x 7.00mm(H)

Dimension_B: 100.10mm(L) x 69.85mm(W) x 9.50mm(H) for 8TB(7680GB) PLP PCBA

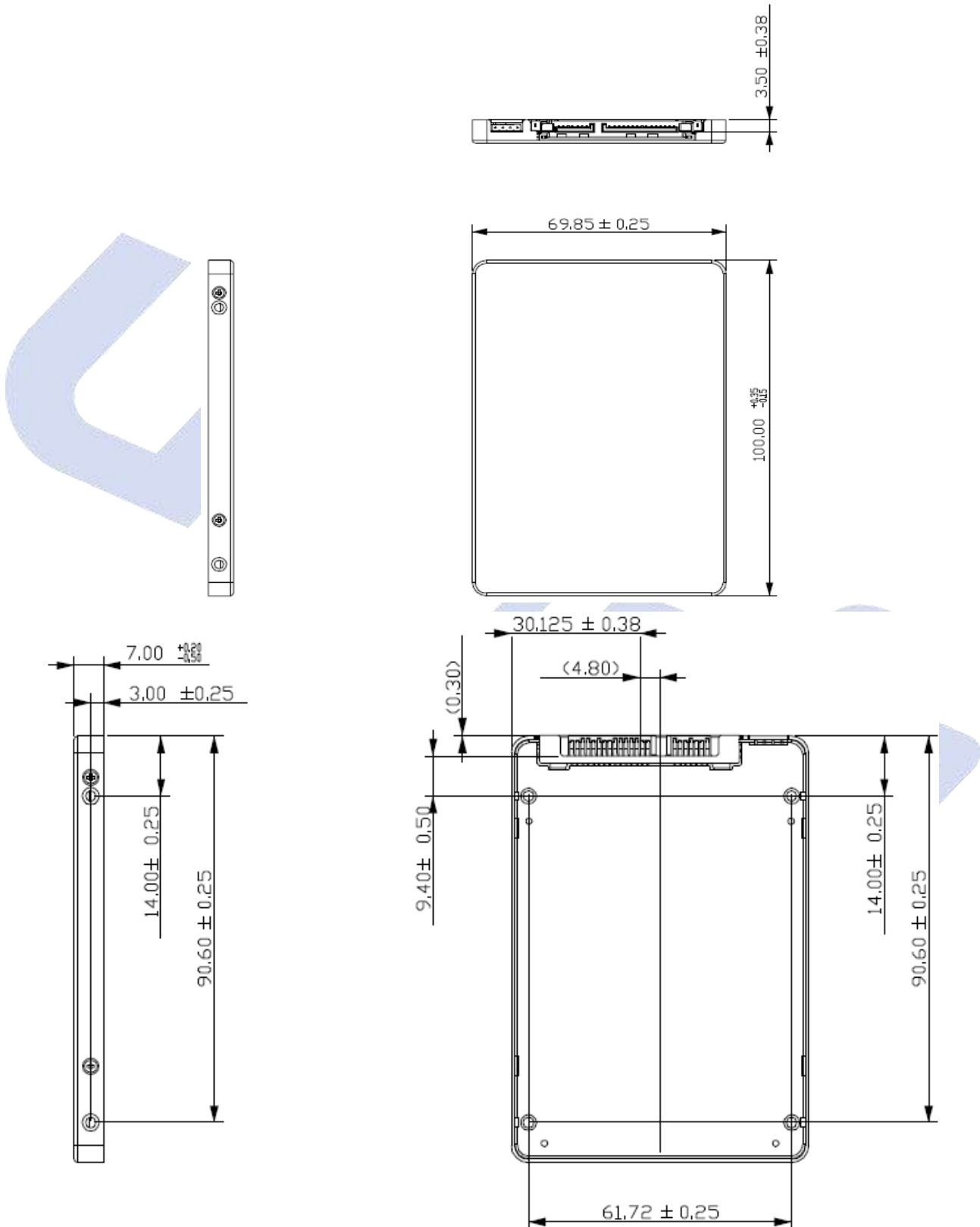

UD info CORP. TEL: +886-2-7713-6050 FAX: +886-2-8511-3151

3F-4, No.8, Ln. 609, Sec. 5, Chongxin Rd., Sanchong Dist., New Taipei City 241, Taiwan (R.O.C.)

8. TERMINOLOGY



The following table is to list out the acronyms that have been applied throughout the document.

Term	Definitions
DDR	Double data rate (SDRAM)
DIPM	Device initiated power management
HIPM	Host initiated power management
LBA	Logical block addressing
MB	Mega-byte
MTBF	Mean time between failures
NCQ	Native command queue
SATA	Serial advanced technology attachment
S.M.A.R.T.	Self-monitoring, analysis and reporting technology
SSD	Solid state disk

9. BARCODE DESCRIPTION



H F 3 2 5 D C 9 6 0 G B A 8 P

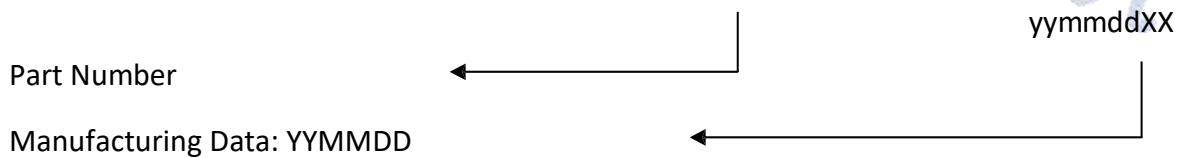

10. PARTNUMBER DECODER



HF3-25DCX⁸X⁹X¹⁰X¹¹X¹²X¹³X¹⁴X¹⁵X¹⁶X¹⁷

X ¹ X ² X ³	X ⁴ X ⁵	X ⁶ X ⁷	X ⁸ X ⁹ X ¹⁰ X ¹¹ X ¹²	X ¹³	X ¹⁴	X ¹⁵	X ¹⁶ X ¹⁷
HF3	25	DC	060GB 120GB 240GB 480GB 960GB	1920G 3840G 7680G 15T3B	A: 3D TLC Standard (0°C ~ +70°C) B: 3D TLC Industrial (-40°C ~ +85°C) V: 3D pSLC Standard (0°C ~ +70°C) W: 3D pSLC Industrial (-40°C ~ +85°C)	8	P blank

X¹⁶X¹⁷

Blank: standard

- 01: Write Protection (WP)
- 03: Quick Erase Jumper (QEJ)
- 06: Conformal Coating (CC)
- 07: CC + WP
- 09: CC + QEJ
- 20: PLP
- 21: PLP + Conformal Coating (CC)
- 28: PLP + AES
- 24: PLP + Quick Erase Jumper (QEJ)
- 30: DEVSLP Function
- 31: AES + OPAL
- 32: PLP + AES + OPAL
- 35: PLP + Write Protect (WP)
- 36: PLP + WP + Conformal Coating (CC)
- 37: PLP + AES + Conformal Coating (CC)
- 44: AES + OPAL + Quick Erase Jumper (QEJ)